

CertainTeed
EverNew[®]

Railing, Porch & Decking Systems



Welcome to the Decking & Railing Collection.

For more than 100 years, homeowners and building professionals have trusted CertainTeed for the highest quality building products, and continually setting the standards for exciting innovations in style and performance.

Today, that spirit of innovation comes to life in the CertainTeed Decking & Railing Collection with the industry's leading array of colors, styles, and performance. The EverNew® railing product lines offer a combination of superior quality and style that has become the premier choice of homeowners and building professionals.

The comforts of home are no longer defined by four walls. Outside living spaces are “in” as porches, yards and gardens are transformed into beautiful open-air rooms. If you're longing for the joys of fresh air living, CertainTeed can help. Our Living Spaces® exterior products suite, including siding, soffit and accessories, porch, decking, railing, fence and roofing products, offers everything you need to create and define your own great outdoors.

CertainTeed's long-standing commitment to innovation, quality and service is firmly rooted in our founding philosophy of “Quality made Certain, Satisfaction Guaranteed.” It's a promise we take as seriously today as we did a century ago.





Get inspiration, see many other great examples of Living Spaces and join in the dialog about improving your outdoor living space by visiting:

 www.facebook.com/certainteedlivingspaces

 www.youtube.com/user/CTLivingSpaces

Finishing Touches 4

Composite Railing Collection

Panorama® 8

Vinyl Railing Collection

Oxford Routed Railing System..... 12

Oxford Bracketed Railing System..... 16

Kingston 20

Vinyl Railing Accessories 24

Decking

EverNew® Vinyl Decking 28

Decking Accessory

UnderShield® 30

Porch Posts, Wraps & Columns

Structural Porch Posts..... 32

Structural Columns 32

Certa-Snap® Wrap 33

Product Matrix 34



On Cover

Railing: Kingston with square balusters in white
Siding: Cedar Impressions Double 7" Staggered Perfection Shingles and Board and Batten in cypress

Adding the WOW Factor



Perfect Together



Mix and Match

Finishing Touches

ADDING THE WOW FACTOR

Here are just a few of many ideas for finishing railing, posts and balusters. With CertainTeed exterior products, there are no limits to the unique personality you can create. And by adding just the right balance of details, you are improving the curb appeal and value of your home.



Kingston with traditional balusters in white



Certa-Snap® in white

Our commitment to safety

CertainTeed products meet stringent requirements for quality and performance. Safe, secure and durable, our railing and deck systems are engineered to provide years of worry-free enjoyment.

Performance that lasts

EverNew® railing products are designed to maintain their integrity over time. Products made of wood may meet code when they're brand new, but can weaken over time — especially after prolonged exposure to the elements. This is an important concern if you're installing railing as a safety barrier on balconies and stairs.

EverNew ensures long-lasting performance by building security into every railing system. Our railing features heavy-duty construction for enduring strength. When it comes to rail-to-post connections, simply using plastic brackets isn't enough. EverNew offers concealed corrosion-resistant stainless steel brackets on our composite railing, and aluminum brackets concealed with molded vinyl covers on our vinyl railing, for critical protection from the elements.

Details make the difference

EverNew railing offers everything you need to install with confidence:

- ◆ Heavy-duty rails offer exceptional durability
- ◆ Secure rail-to-post connections
- ◆ Stainless-steel and aluminum rail mount brackets provide added strength
- ◆ Railing heights approved for deck, balcony, porch and stair applications
- ◆ Concealed hardware won't rust or corrode
- ◆ Splinter-free surfaces
- ◆ Class A flame-spread rating for a safer outdoor environment
- ◆ Outstanding warranty coverage with exclusive SureStart™ parts and labor protection



Kingston with square balusters in white

Meeting the standards of the ICC

The ICC (International Code Council) is an independent, nonprofit organization responsible for the development of national model construction codes. The ICC Evaluation Service, Inc. (ICC-ES) is the leading source of technical information on building codes, products and technology in the United States. ICC-ES conducts technical evaluations of building products, components, methods and materials. Building industry professionals look to ICC-ES evaluation reports for evidence that products and systems meet code requirements.

EverNew railing systems comply with the standards established by the ICC. The Panorama® composite railing system and Oxford and Kingston vinyl railing systems have undergone third party testing as designated respectively in reports CCRR-0115, CCRR-0187 and CCRR-0211.

Sustainability for a lifetime

CertainTeed respects the environment through the responsible development of sustainable building products and systems. CertainTeed EverNew railing products give building professionals and homeowners confidence that the homes they design, build, maintain, and occupy are made with sustainable materials that enhance every project's performance and beauty.



For more information on CertainTeeds Life Cycle Assessment Report go to www.certainteed.com/BuildingResponsibly/LifeCycleAssessment

**CERTAINTEED EVERNEW®:
YOUR ONE-STOP SOURCE
FOR QUALITY PRODUCTS**

EverNew railing is designed to keep its good looks for years to come, without a lot of maintenance. It won't warp, rot, split or corrode, and it never needs staining or painting.

Easy-living benefits

- ◆ Consistent quality and appearance
- ◆ Easy to install and clean
- ◆ Concealed fasteners
- ◆ Virtually maintenance-free; no painting or staining
- ◆ Class A flame-spread rating
- ◆ Safe and secure
- ◆ Outstanding warranty coverage
- ◆ SureStart protection

Rest-assured features

pressure-treated wood	VS.	EverNew® railing and deck systems
Short lifespan		Exceptional durability
Inconsistent quality		Consistent quality
Very high maintenance		Low maintenance
Prone to rot and decay		No rot or decay
Splinters, cracks, knots		No splinters, cracks or knots
Toxic chemical preservatives		No toxic chemical preservatives
Class C fire rating		Class A flame-spread rating



Pressure-treated wood

EverNew vinyl

“On center” installation

All EverNew railing products feature “on center” spacing. EverNew railing products are available in 6', 8' and 10' (nominal) lengths. This size offering equals easier and quicker installation with less waste.

Choose the EverNew system that's right for you

Vinyl:

- ◆ Durable construction – weatherable vinyl exterior with aluminum reinforced rails offers low maintenance
- ◆ Precision-fit components provide a snug, secure fit with fast and easy installation
- ◆ Safe and sound metal-to-wood and metal-to-metal rail-to-post connections
- ◆ Convenient packaging in complete section boxed kits
- ◆ Wide variety of accessories, including posts, caps, and post trims that coordinate with all railing systems

Capped composite:

- ◆ Solid construction – a blend of PVC and recycled wood flour with high-quality PVC capstock for low maintenance
- ◆ Precision-drilled components provide fast and easy installation
- ◆ Secure metal-to-wood rail-to-post connection
- ◆ Convenient packaging in complete section boxed kits
- ◆ Designed to work with a variety of vinyl accessories, including posts and handrail

With EverNew, you can rest assured that years from now our products will perform as beautifully and securely as the day they were installed. CertainTeed stands behind the EverNew decking and railing products with exceptional warranty protection, for your added assurance of quality and safety.



All of CertainTeeds decking and railing products are covered by SureStart protection for a specific period. Under this warranty feature, CertainTeed, at no charge, will repair or replace, at its option, any product proven to be defective during the applicable SureStart period (see actual warranty for details).

Panorama®



Panorama with square balusters in white

COMPOSITE RAILING SYSTEM

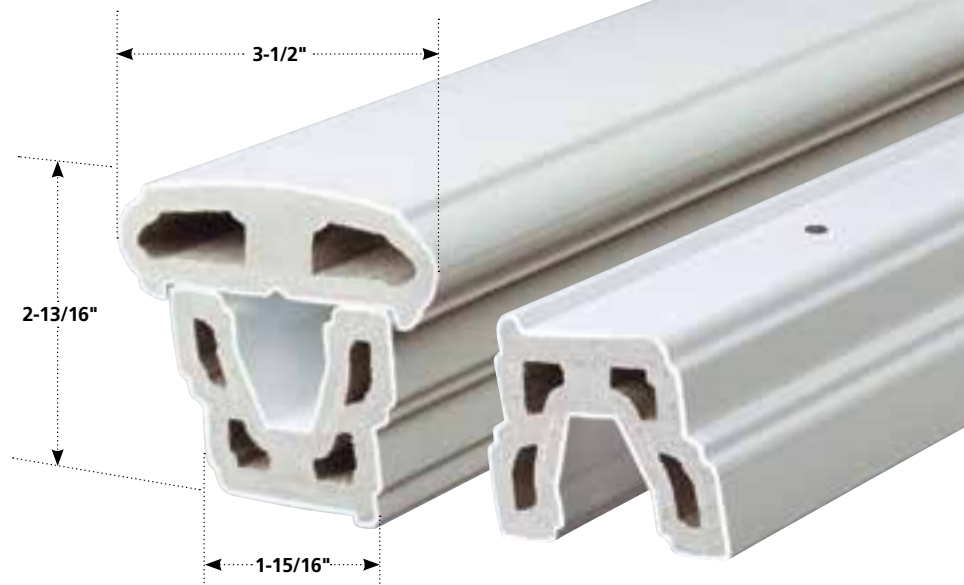

The Panorama® capped composite railing system features a classic painted wood railing design with handcrafted authenticity and true architectural details you won't find on any other composite railing. Panorama's concealed, corrosion-resistant stainless steel hardware provides a seamless appearance and years of worry-free performance. Panorama integrates with CertainTeed's vinyl accessories, allowing you to create exciting new exterior designs.

- ◆ Classic painted wood style with true architectural details
- ◆ Top and bottom universal rails with a decorative top rail cap
- ◆ Concealed external rail-to-post connection for flat, stair, column and 45° applications
- ◆ Available in two heights and two lengths
- ◆ Available in two colors: white and almond
- ◆ Choice of two baluster styles: square composite and decorative steel
- ◆ Powder-coated, hot-dipped galvanized steel decorative balusters create a rustic yet customizable system approach for both flat and stair applications
- ◆ Suitable for one- and two-family dwellings/townhouses not more than three stories high
- ◆ Independent tested as designated in report CCRR-0115
- ◆ Class A flame-spread rating
- ◆ 25-year limited warranty with 2-year SureStart™ protection

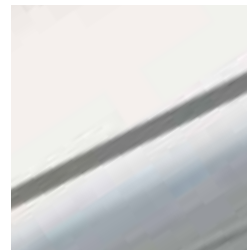

White

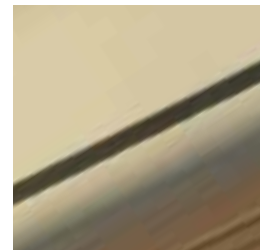

Almond

Decorative Steel Baluster Styles Finishes: Antique Bronze and Oil-Rubbed Bronze

5/8" square; four styles of powder-coated galvanized steel, pre-cut to 26.75" to yield 36" finished rail height; for either flat or stair

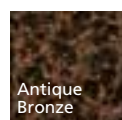

Antique Bronze

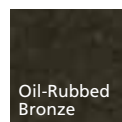

Oil-Rubbed Bronze



Straight



Twist



Single Basket



Double Basket

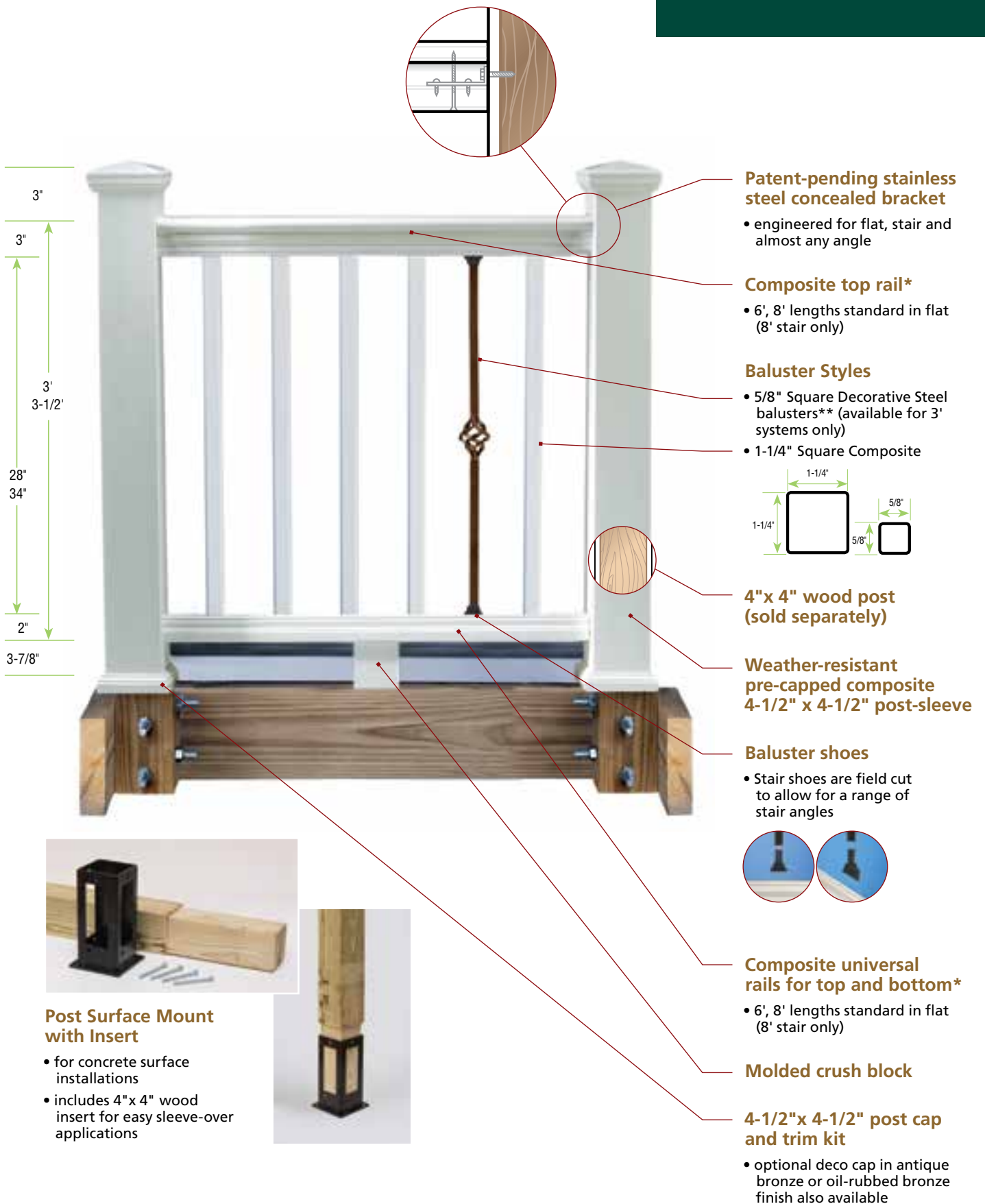

Post Surface Mount with Insert

- for concrete surface installations
- includes 4" x 4" wood insert for easy sleeve-over applications



Composite universal rails for top and bottom*

- 6', 8' lengths standard in flat (8' stair only)

Molded crush block

4-1/2" x 4-1/2" post cap and trim kit

- optional deco cap in antique bronze or oil-rubbed bronze finish also available

*Refer to product matrix for actual product specifications.

**Decorative Steel Balusters install using patented baluster shoe plugs.

THE SOLID LOOK AND FEEL
OF WOOD WITHOUT
THE MAINTENANCE



Panorama in white with twist balusters in antique bronze finish



Panorama with composite square balusters in almond

Post sleeve

accommodates standard
4" x 4" wood posts in 40",
54" and 108" lengths

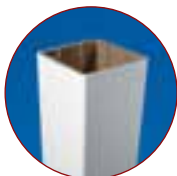

4-1/2" x 4-1/2" square



4-1/2" x 4-1/2"
square

Post cap and trim kit



Optional deco cap accessory snaps onto
Panorama post cap. Available in antique
bronze and oil-rubbed bronze finish to
coordinate with decorative steel balusters.



Oxford with colonial balusters in white
EverNew® Vinyl Decking in gray

VINYL ROUTED RAILING SYSTEM

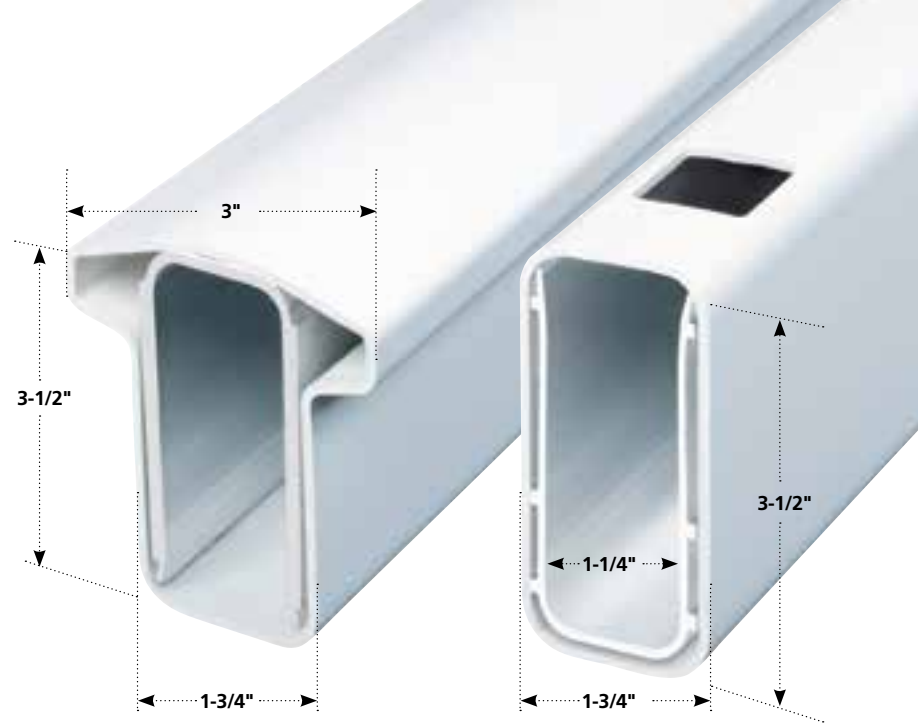

For safe, secure vinyl railing applications, there's no better choice than the Oxford routed system. The routed Oxford system features a unique internal rail-to-post connection and hidden hardware, so there are no unsightly brackets to detract from the look of the railing. The aluminum reinforced rail connects to a sturdy galvanized post support kit inside the routed post, for a completely concealed metal-to-metal connection.

- ◆ "T"-rail top and 2 x 4 bottom rail with hidden hardware system
- ◆ Aluminum reinforced rail connects to sturdy galvanized steel post support kit inside the routed post
- ◆ Posts routed specifically for all post applications
- ◆ Available in two heights and three lengths
- ◆ Available in three colors: white, almond and clay
- ◆ Choice of three baluster styles: square, colonial and glass
- ◆ Suitable for residential and commercial applications – including multifamily and over three story installations
- ◆ Canadian railing code compliant up to 8' span for exterior guard rail system for one- and two-family dwellings
- ◆ Independent tested as designated in report CCRR-0187
- ◆ Meets IBC standards for building safety
- ◆ Class A flame-spread rating
- ◆ Lifetime limited transferable warranty with 5-year SureStart™ protection



White



Almond

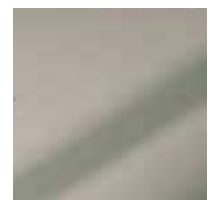

Clay



Oxford with square balusters in white

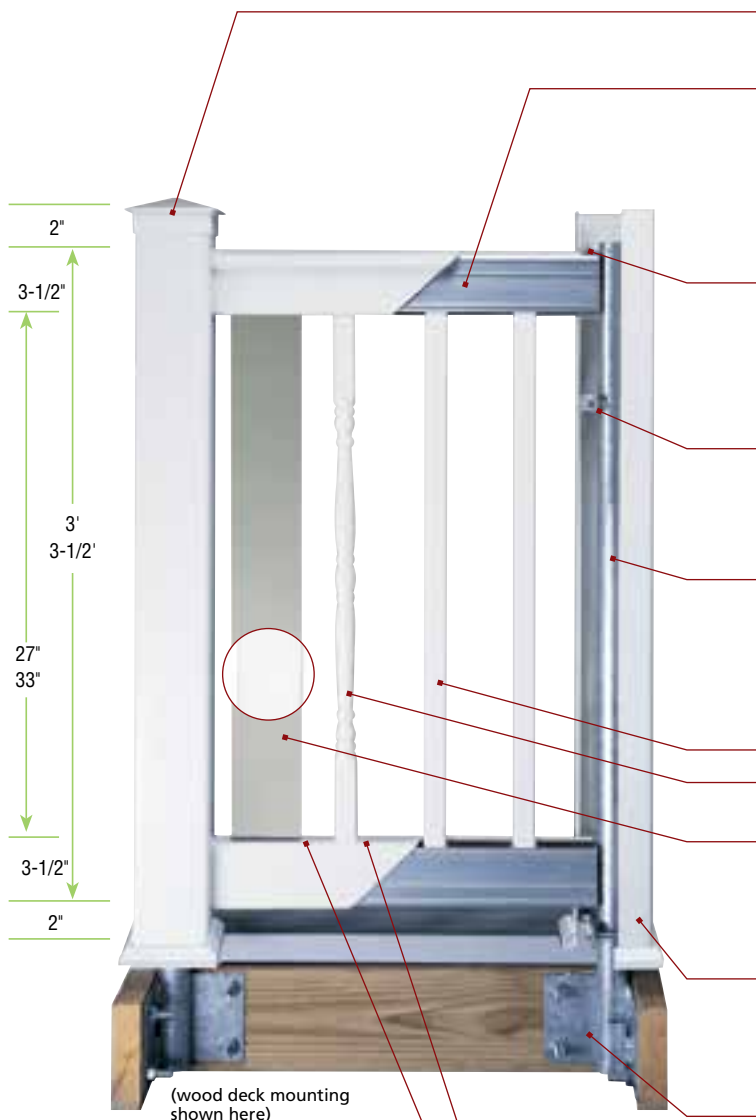

Post caps and trims

Aluminum reinforced top and bottom rail*

- 6' and 8' lengths standard in flat, stair and steep stair
- 10' lengths standard in flat and stair

Rail plate

- Made of stainless steel
- Screw flange secures top rails inside post
- Oval cut out works for all flat and stair applications

E-Z Set brackets

- Made of aluminum
- Keeps post square and snug

Sturdy post support pipe

- Hot-dipped galvanized steel
- 1-5/8" outside diameter

Baluster styles

- Square
- Colonial (white and almond only)

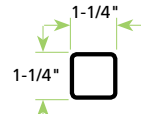

4" tempered glass baluster infill

- Clear available in 3-1/2' only
- Smoked available in 3-1/2' only

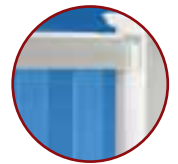

Weather-resistant vinyl post sleeve

- Square available in 3' and 3-1/2' heights

Secure post mounting systems

- Post support kits provided for both wood and concrete applications

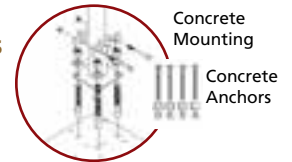

Hardware options for concrete post support kit

- Self leveling kit for concrete post support kits; ideal for ramps
- Stainless steel hardware kit for the concrete post support kit is also available to deliver improved corrosion resistance. Ideal for coastal climates



Attractive precision-fit components

Baluster hole spacing

- Top and bottom rails are routed to accept 1-1/4" x 1-1/4" balusters
- Stair baluster spacing is wider to account for racking

Stair/step section

- Post center spacing on diagonal: 6' section covers 68" at 32°
- 8' section covers 90" at 32°, 10' section covers 117" at 32°
- 6' section covers 71" at 42°, 8' section covers 96" at 42°

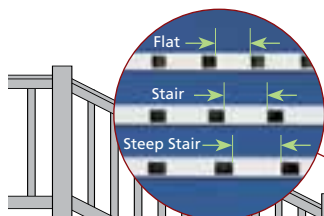

Standard: 25° min–37° max
Steep stair: 37° min–42° max

*Refer to product matrix for actual product specifications.

METAL-TO-METAL SYSTEM

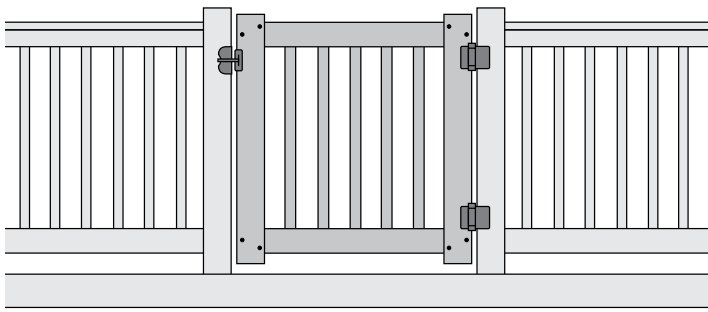

Oxford Gate Kit

Improved design for enhanced performance and easier ordering

- Heavy duty internal aluminum frame
- Stainless steel fasteners
- Features 2x4 rails
- High quality gate hardware
- Available in all colors, both heights, and square & colonial balusters
- Self closing hinges
- Easy to assemble

Routed Post Options

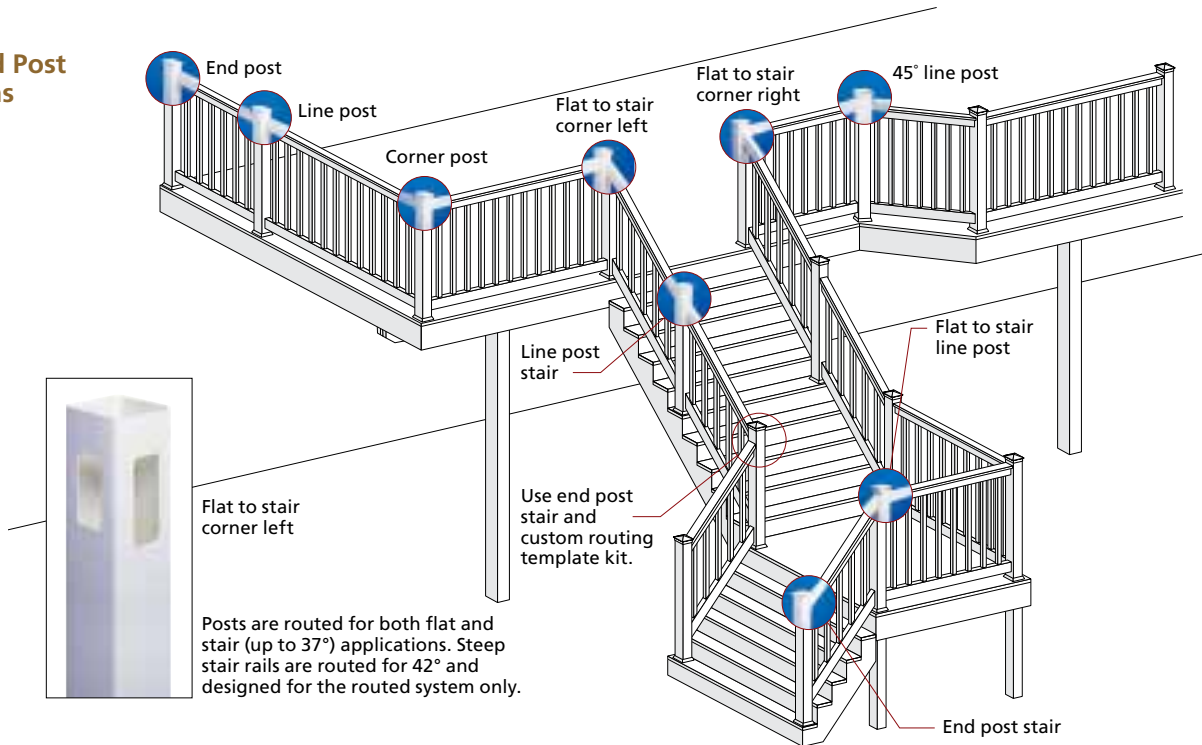

EverNew glass balusters combine high-end style with the quality and performance features that are distinctly CertainTeed. Our glass balusters are designed to work with either the routed or bracketed Oxford railing system.

- ◆ Choice of clear or smoked 4" x 3/8" tempered glass
- ◆ Beveled balusters work for flat and stair applications
- ◆ 3-1/2' baluster height provides a clear view
- ◆ Routed rails eliminate the need to fasten and screw balusters without extra brackets
- ◆ Bracketed and routed post connections
- ◆ Suitable for one- and two-family dwellings/townhouses that are not more than three stories high
- ◆ Independent tested as designated in report CCRR-0187
- ◆ Lifetime limited transferable warranty with SureStart™ protection



Clear Balusters



Smoked Balusters

Oxford



Oxford in white with glass balusters in clear

VINYL BRACKETED RAILING SYSTEM

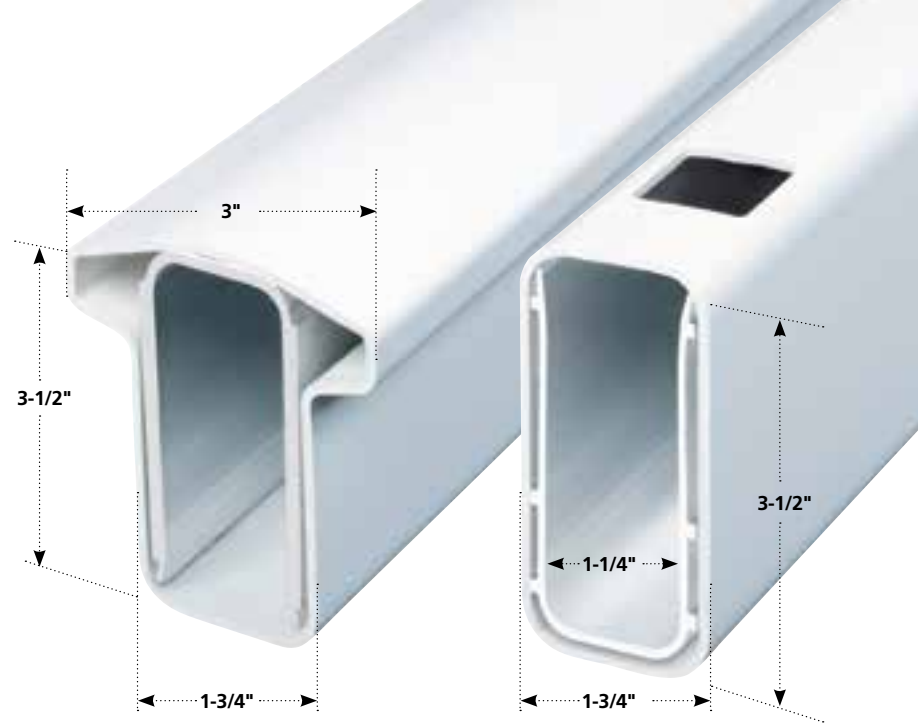

Designed for use with existing wood posts, the Oxford bracketed railing system offers everything you need for a safe and secure railing installation. Oxford goes the extra mile with standard features like concealed aluminum rail mount brackets and stainless steel screws, for long-lasting strength and peace of mind.

- ◆ "T"-rail top and 2 x 4 bottom rail for sleeve-over installations
- ◆ Aluminum rail mount brackets provide a safe and secure, metal-to-metal rail-to-post connection for greater strength and longevity
- ◆ Available in two heights and three lengths
- ◆ Available in three colors: white, almond and clay
- ◆ Choice of three baluster styles: square, colonial and glass
- ◆ Suitable for residential and commercial applications – including multifamily and over three story installations
- ◆ Canadian railing code compliant up to 8' span for exterior guard rail system for one- and two-family dwellings
- ◆ Independent tested as designated in report CCRR-0187
- ◆ Meets IBC standards for building safety
- ◆ Class A flame-spread rating
- ◆ Lifetime limited transferable warranty with 5-year SureStart™ protection



White



Almond

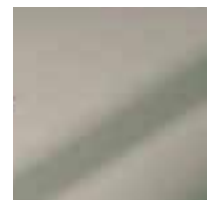

Clay



Oxford with square balusters in white

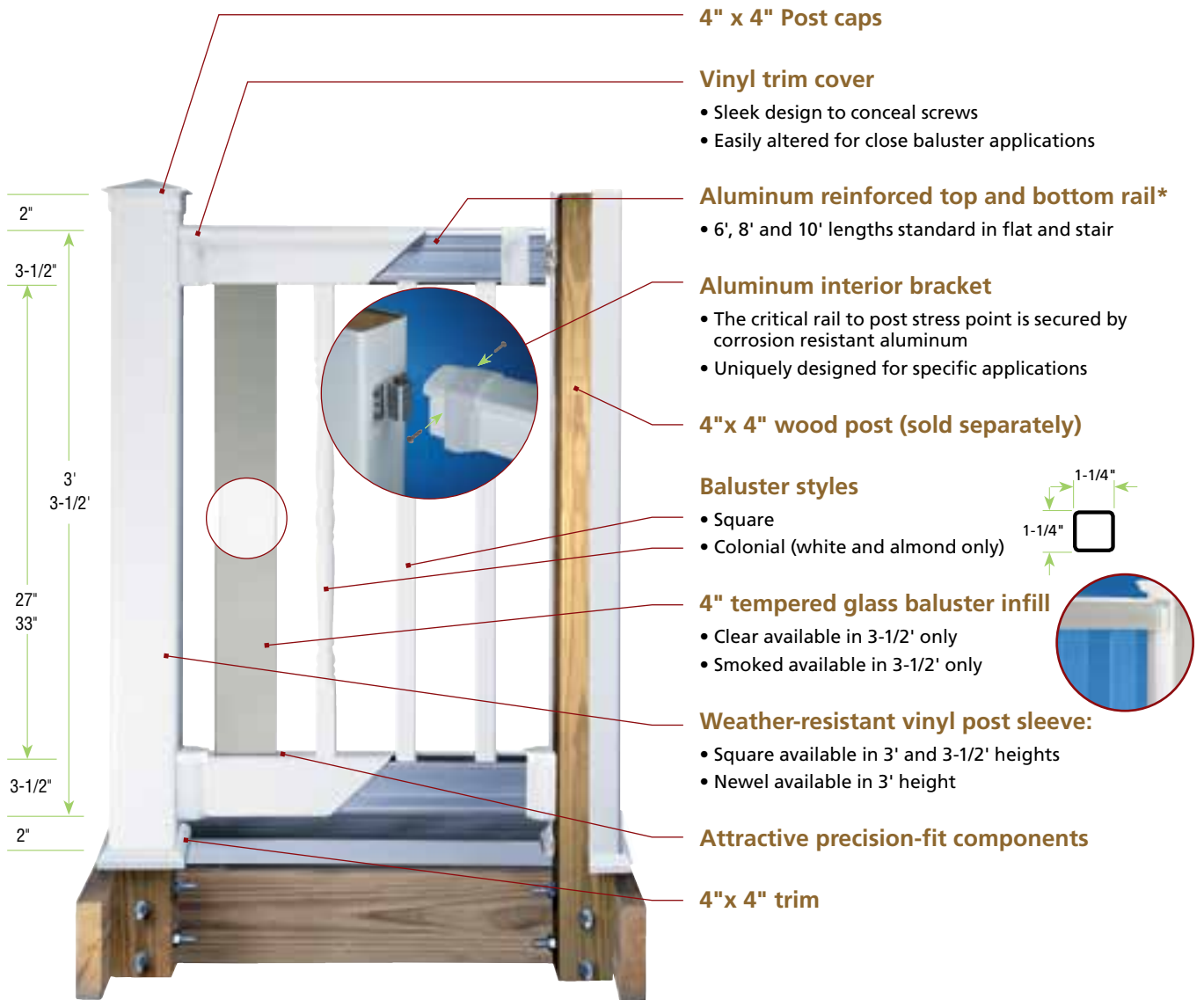

4" x 4" Post caps

Vinyl trim cover

- Sleek design to conceal screws
- Easily altered for close baluster applications

Aluminum reinforced top and bottom rail*

- 6', 8' and 10' lengths standard in flat and stair

Aluminum interior bracket

- The critical rail to post stress point is secured by corrosion resistant aluminum
- Uniquely designed for specific applications

4"x 4" wood post (sold separately)

Baluster styles

- Square
- Colonial (white and almond only)

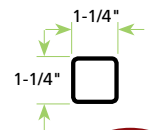

4" tempered glass baluster infill

- Clear available in 3-1/2' only
- Smoked available in 3-1/2' only

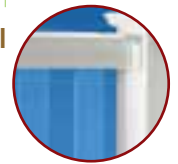

Weather-resistant vinyl post sleeve:

- Square available in 3' and 3-1/2' heights
- Newel available in 3' height

Attractive precision-fit components

4"x 4" trim

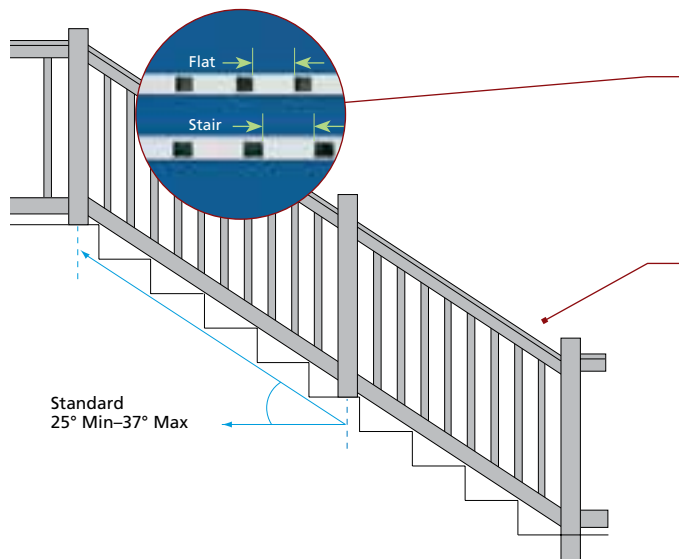

Baluster hole spacing

- Top and bottom rails are routed to accept 1-1/4" x 1-1/4" balusters
- Stair baluster spacing is wider to account for racking

Stair/step section

- Post center spacing on diagonal:
6' section covers 68" at 32°
- 8' section covers 90" at 32°
- 10' section covers 117" at 32°

*Refer to product matrix for actual product specifications.

Oxford Bracket Options – Uniquely designed for specific applications

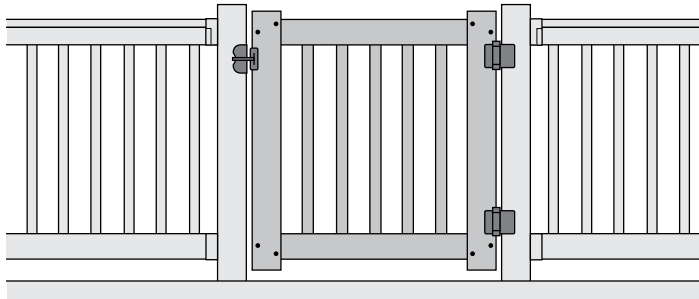

Oxford Gate Kit

Improved design for enhanced performance and easier ordering

- Heavy duty internal aluminum frame
- Stainless steel fasteners
- Features 2x4 rails
- High quality gate hardware
- Available in all colors, both heights, and square & colonial balusters
- Self closing hinges
- Easy to assemble

Secure Connection

Aluminum brackets and corrosion-resistant stainless steel screws complete the connection between post and rail to provide a strong and reliable system.



flat



column (minimum 8" round)



stair (field alteration)



45°



Oxford with colonial balusters in white

Kingston



Kingston with square balusters in white

VINYL RAILING SYSTEM

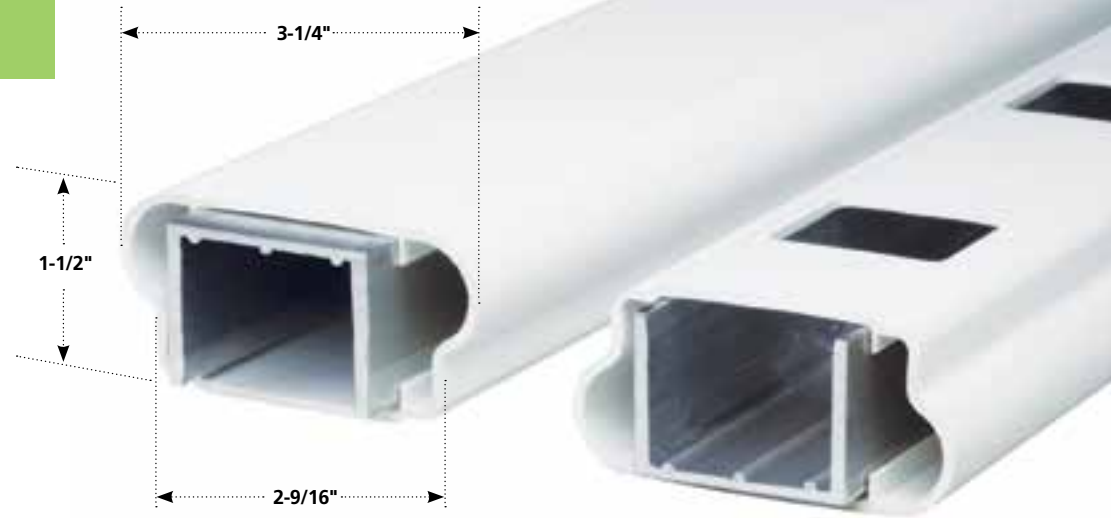

Kingston offers premium features you'd expect to find on higher-end systems, including high-quality aluminum rail mount brackets for superior safety and security. Secured by provided stainless steel fasteners, the aluminum brackets are completely concealed by molded vinyl covers, so you never have to worry about rust or corrosion.

- ◆ Classic bread-loaf rail design (on both top and bottom rails) for sleeve over applications
- ◆ Aluminum rail mount brackets provide a safe and secure metal-to-metal, rail-to-post connection for greater strength and longevity
- ◆ Unique molded vinyl bracket covers designed for flat, stair, column, 45° and 22-1/2° applications
- ◆ Available in two heights and three lengths
- ◆ Available in three colors: white, almond and clay
- ◆ Choice of two baluster styles: square and traditional
- ◆ Suitable for one- and two-family dwellings and townhouses not more than three stories high
- ◆ Canadian railing code compliant up to 8' span for exterior guard rail system for one- and two-family dwellings
- ◆ Independent tested as designated in report CCRR-0211
- ◆ Meets IRC standards for building safety
- ◆ Class A flame-spread rating
- ◆ Lifetime limited transferable warranty with 5-year SureStart™ protection



White



Almond

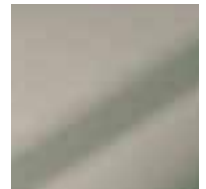

Clay



Kingston with traditional balusters in white

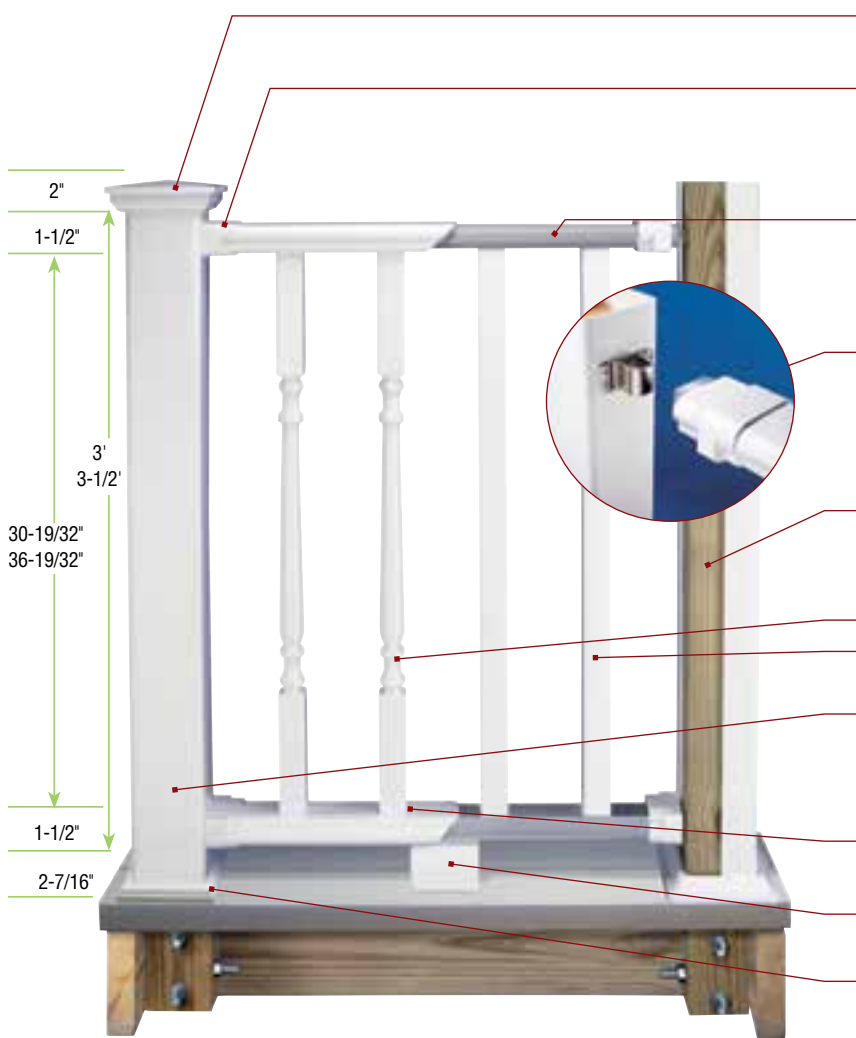

4" x 4" Post caps

Vinyl trim cover

- Sleek design to conceal screws and streamline appearance
- Easily altered for close baluster applications

Rugged aluminum reinforced top and bottom rail*

- 6', 8' and 10' lengths standard in flat and stair (10' flat only)



Aluminum interior bracket

- The critical rail to post stress point is secured by corrosion resistant aluminum
- Uniquely designed for specific applications

4" x 4" wood post (sold separately)

Baluster styles

- Traditional (3' White and Almond only)
- Square

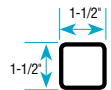

Weather-resistant vinyl post sleeve in either square or newel available in 3' and 3-1/2' heights

Attractive precision-fit components

Molded crush block

4"x 4" trim

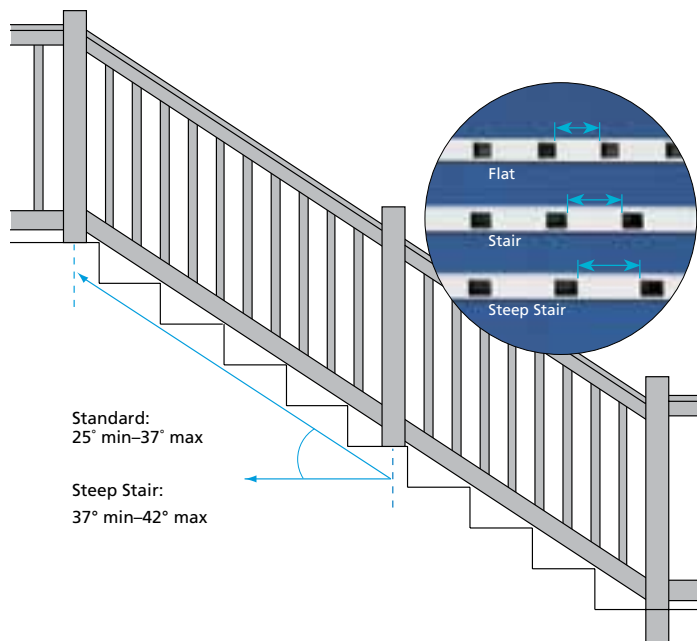

Baluster hole spacing

- Top and bottom rails are routed to accept 1-1/2" x 1-1/2" balusters.
- Stair baluster spacing is wider to account for racking.

Stair/step section

- Post center spacing on diagonal:
6' section covers 70" at 32°;
8' section covers 95" at 32°

*Refer to product matrix for actual product specifications.



Kingston with square balusters in clay

Trim covers



column
(min 8" round)



standard and steep stair applications
(longer cover allows for field cutting)

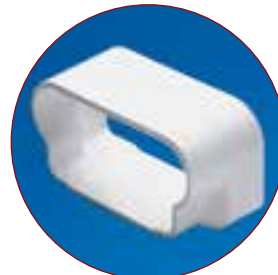

flat



45°



22-1/2° left, 22-1/2° right

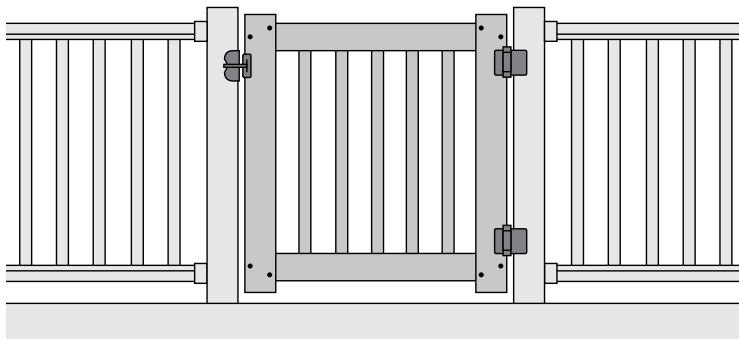

Kingston Gate Kit

Designed for enhanced performance and easy ordering

- Heavy duty internal aluminum frame
- Stainless steel fasteners
- Features 2" x 3-1/2" rails
- High quality gate hardware
- Available in all colors, all heights and all balusters
- Self closing hinges
- Easy to assemble

Vinyl Railing Accessories

Square post and caps

Vinyl blank posts available in...
4"x4": 38", 44", 48", 51-1/2", 107"
5"x5": 68", 107"
6"x6": 120"



Square post



Flat cap internal Flat cap external New England cap Flat Pyramid cap (6"x6" only)



Gothic cap Ball cap New England cap w/ deco finish*

Newel post and caps

4"x4" newel post and caps create a more traditional look on your EverNew railing. Blank newel posts available in 38" and 44" for white 3' styles only.



Newel post



King cap Queen cap

Post trim

Post trim can be used for finishing vinyl posts. Available in white, almond, and clay.



4-piece post trims
 Available in 4"x4" and 5"x5"
 (matches porch post trims)
 Also available in 6"x6"
 (Adjusts to fit 4" to 6-1/2" posts)



1-piece post trims
 Available in 4"x4" and 5"x5"
 2-piece post trims
 Available in 4"x4"

Post Support Kits (at a glance)

"Original" Post Support Kit	EZ Set II Bracketed Post Support Kit	The Mount Post Support Kit	Post Surface Mount with Wood Insert
For Routed System**	For Bracketed Systems		
Oxford	Oxford Kingston	Oxford Kingston	Panorama
Wood & Concrete	Concrete	Wood or Concrete	Concrete

**Also suitable for use with Blank Newel Posts.

Not all accessories available in all colors. Refer to product catalog for colors and style availability.
 *Aluminum cap with your choice of black or antique bronze finish. Available in 4"x4" and 5"x5" sizes

ADD THE PERFECT FINISHING TOUCH WITH DECORATIVE POST CAPS AND TRIM

Decorative Post Caps and Post Trim for 4" x 4" posts

Our Decorative post caps and post trims feature an innovative metallic and ceramic powder coated injection molded product line to enhance your fence or deck posts. The product line includes solar lighted post caps, post caps, and post trims. These products will not tarnish like stamped metal post caps.

Post Caps



patina



post cap in antique gray

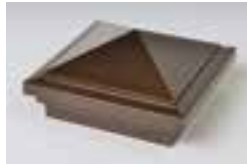

antique brown



antique copper



antique gold

Post Trim

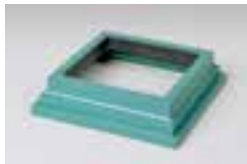

patina

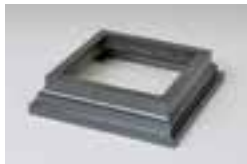

antique gray



antique brown



antique copper



antique gold

Solar Post Caps



patina



antique gray



antique brown



antique copper



antique gold

Solar Accent Lighting

These solar powered lights have extremely efficient LED circuits powered by two rechargeable batteries. They are easy to install, are low maintenance, environmentally friendly and perfect for remote locations as they require no electricity. The taller solar post caps will fit 4"x 4" and 5"x 5" posts.



Solar Post Caps



white



black

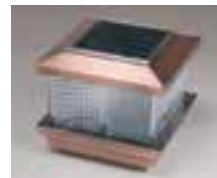

copper



stainless

Solar Wedge



white



black



copper



stainless

Batteries are included with all solar caps and wedge lights.

Vinyl handrail component system

- ◆ Complies with ADA (Americans with Disabilities Act) requirements for grippable hand rails
- ◆ 1-1/2" diameter gripping area
- ◆ Continuous hand rail runs
- ◆ Safe for stair and ramp applications
- ◆ Aluminum reinforced construction reduces bowing and provides enduring strength
- ◆ Functional finishing touches: post and wall returns, end caps, return loops and a convenient straight joiner
- ◆ Unique adjustable internal joiner accommodates any transition – 0° to 90° bends
- ◆ Installs easily on site with no preformed fittings
- ◆ Ideal for use with EverNew railing systems
- ◆ Virtually maintenance free
- ◆ Class A flame-spread rating
- ◆ Lifetime limited warranty
- ◆ EZ Set bracket kit available for attachment to routed system



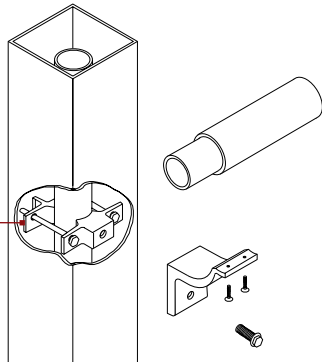

White

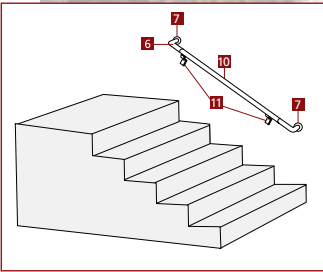
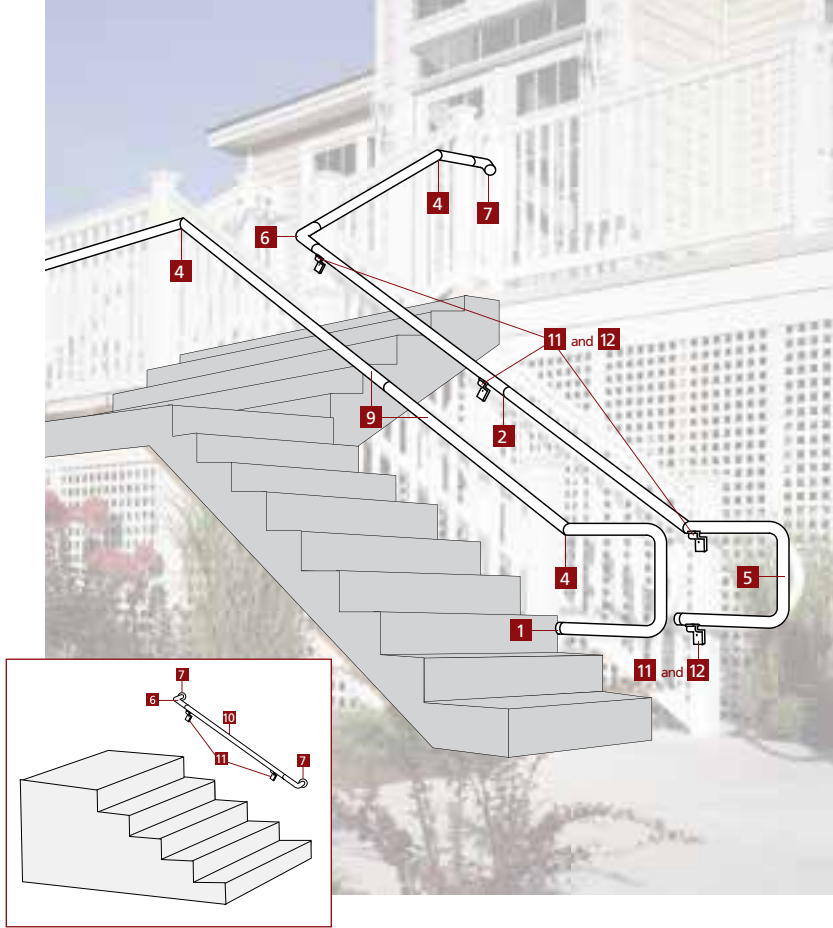

Note: Hand rail depicted is not free standing and must be anchored to walls or guardrail using hand rail bracket assembly (74028/74029). Space a maximum of 6' on center and as close as possible to both sides of any joint. (ADA compliant at 6ft spans)

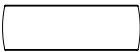

- 1** 1-1/2" diameter vinyl end cap
- 2** Straight aluminum joiner 
- 3** Straight wall return (includes vinyl trim)
- 4** Adjustable aluminum internal joiner 
- 5** 1-1/2" OD ADA 180° return loop
- 6** 1-1/2" OD - 90° corner - includes two 3" aluminum joiners
- 7** 1-1/2" OD - 90° wall return - includes 3" aluminum joiner
- 8** 1-1/2" OD x 80" vinyl hand rail with aluminum insert
- 9** 1-1/2" OD x 104" vinyl hand rail with aluminum insert
- 10** 1-1/2" OD x 120" vinyl hand rail with aluminum insert
- 11** Hand rail bracket assembly
- 12** Hand rail EZ Post attach kit

REINFORCED GATE KITS



Kingston Gate

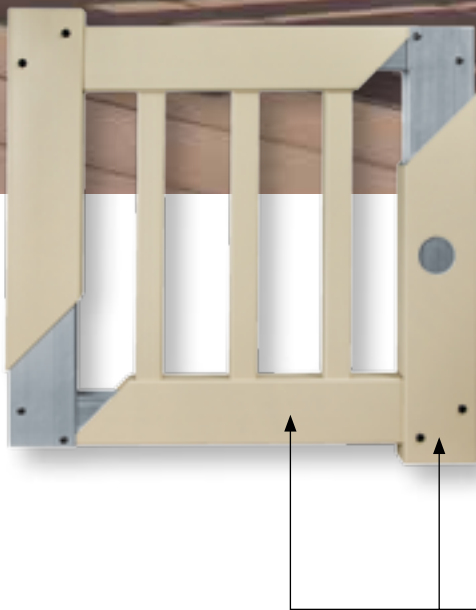

EverNew Gate Kits

EverNew gates feature a heavy-duty internal aluminum frame for sturdy construction that's built to last and stainless steel fasteners to prevent corrosion.

- ◆ Available for Oxford and Kingston railing systems
- ◆ Kit includes all parts needed to build a railing gate up to 60" wide
- ◆ Aluminum reinforced uprights and rectangular rails
 - Balusters
 - Upright caps
 - Stainless steel screws
 - Black nylon gate hinges (self closing)
 - Latch



EverNew Vinyl Decking in gray
Panorama® with square balusters in white

VINYL DECKING

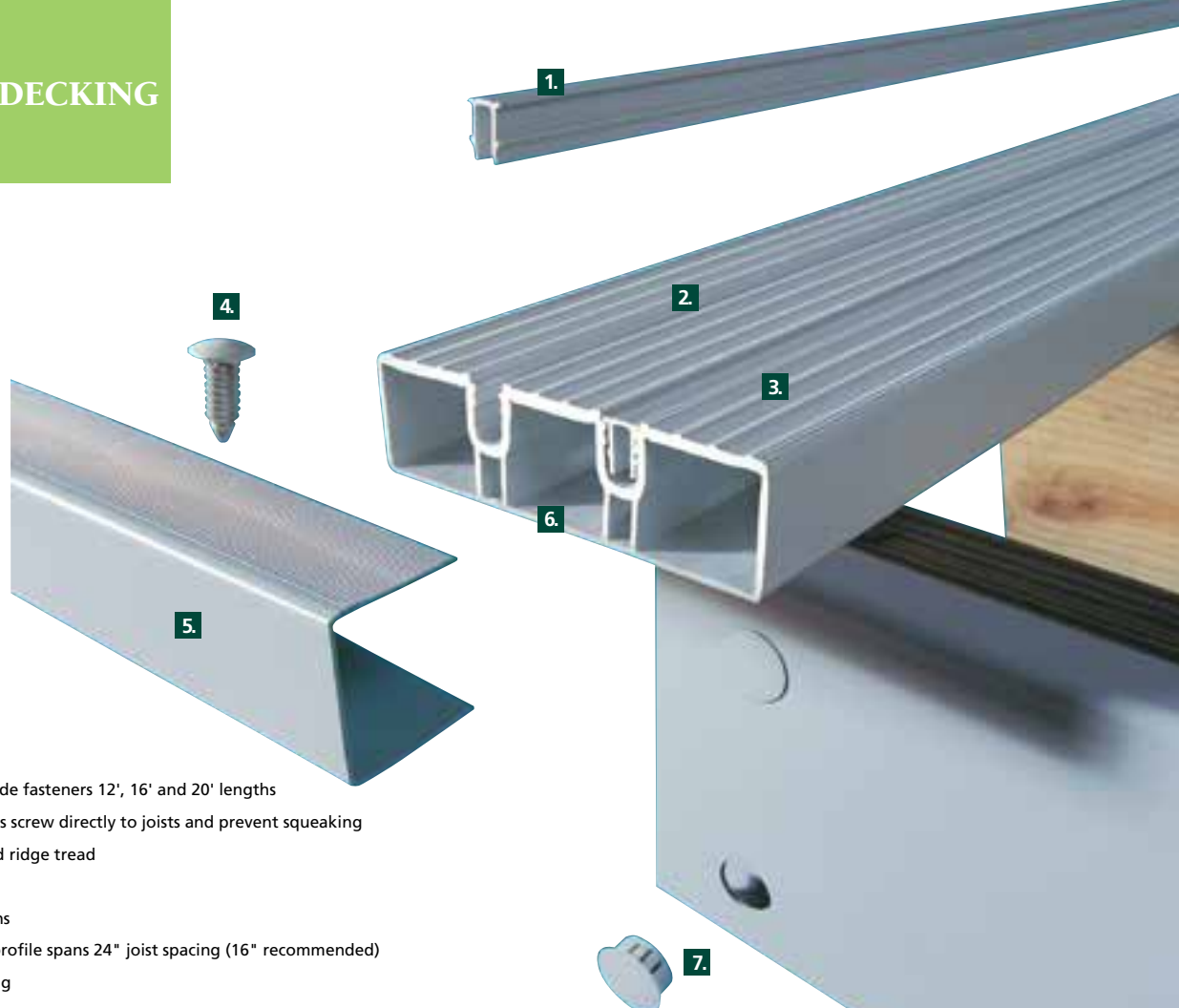

1. Snap-in fill pieces hide fasteners 12', 16' and 20' lengths
2. Easy-to-install planks screw directly to joists and prevent squeaking
3. Safe, non-slip, raised ridge tread
4. End cover fastener
5. End cover 12' lengths
6. Rigid multi-ribbed profile spans 24" joist spacing (16" recommended)
7. 3/4" fascia cover plug

Easy to install, easy to maintain... EverNew's easy to clean deck surface is perfect for busy, no-maintenance lifestyles.

- ◆ Available in 12', 16' and 20' lengths
- ◆ No visible screws or exposed hardware
- ◆ Easy to clean, non-porous vinyl surface
- ◆ Will not stain from spills
- ◆ Excellent color retention
- ◆ Cool to the touch – Barefoot Friendly™
- ◆ Independent tested as designated in report CCRR-0219
- ◆ Lifetime limited transferable warranty with 5-year SureStart™ protection

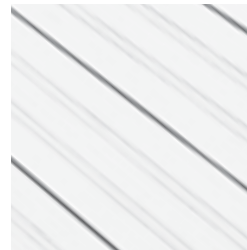

White

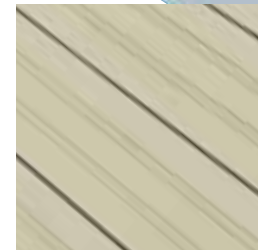

Almond

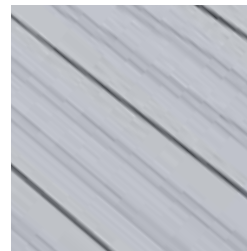

Gray

EverNew® Vinyl deck boards and fascia

	Actual Width	Actual Thickness	Available Lengths
2x6 Deck boards	5-1/2"	1-1/2"	12', 16', 20'
Fascia	1-1/2", 3", 6"	7/8"	8'

Please see product samples before making final selection.



UnderShield® creates new possibilities for your home.

A beautiful deck is easy to love, from the top. Now, you can love your deck from underneath as well, with the beautiful possibilities of UnderShield®. A unique, vinyl shield and ceiling system, UnderShield turns an unsightly deck underside into a dry, beautiful ceiling, creating limitless options for new exterior living spaces.



Beaded panel in colonial white shown with gutter collection system.



Custom Restoration Millwork® columns and brackets, combined with the UnderShield Water Diversion System, creates a formal yet inviting area.



Under the deck is a perfect area for storage of frequently used outdoor toys, lawn and garden equipment and more.

DECKING ACCESSORY

Designed to respond to the needs of building professionals and homeowners, UnderShield is easy to install to new or existing decks, and will maintain unobstructed air flow when properly installed. Panels can run parallel or perpendicular to the home, and an easy-to-use clip creates the desired pitch.

- ◆ Low maintenance water diversion system
- ◆ Easy to install adjustable grid system
- ◆ Concealed clip system
- ◆ Stainless steel hardware provides security and lasting performance
- ◆ High quality vinyl panels available in 6" x 16'
- ◆ Installs under the deck joist
- ◆ No need to worry if the framing is 12" or 16" on-center
- ◆ No concern with bracing between joists
- ◆ Helps maintain the required ventilation under the deck for most composite deck boards
- ◆ Choice of two panel styles: beaded or chamfer
- ◆ Available in three colors: colonial white, sterling gray or savannah wicker
- ◆ Suitable for one- and two-story residential applications
- ◆ Class A flame-spread rating
- ◆ Lifetime limited warranty

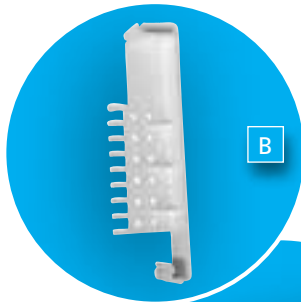

B Clip System comes with all stainless steel hardware (not shown)

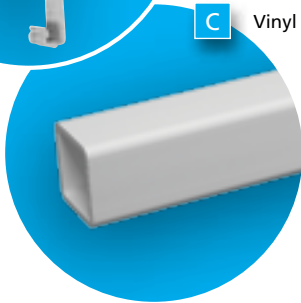

C Vinyl Grid System

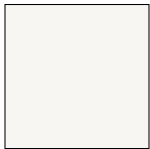

Colonial White



Sterling Gray

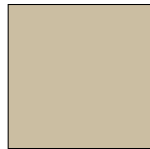

Savannah Wicker

UnderShield is available in beaded or chamfer panels (A). System also includes clips (B), grid system (C), fascia panels and stainless steel hardware (not shown).



A

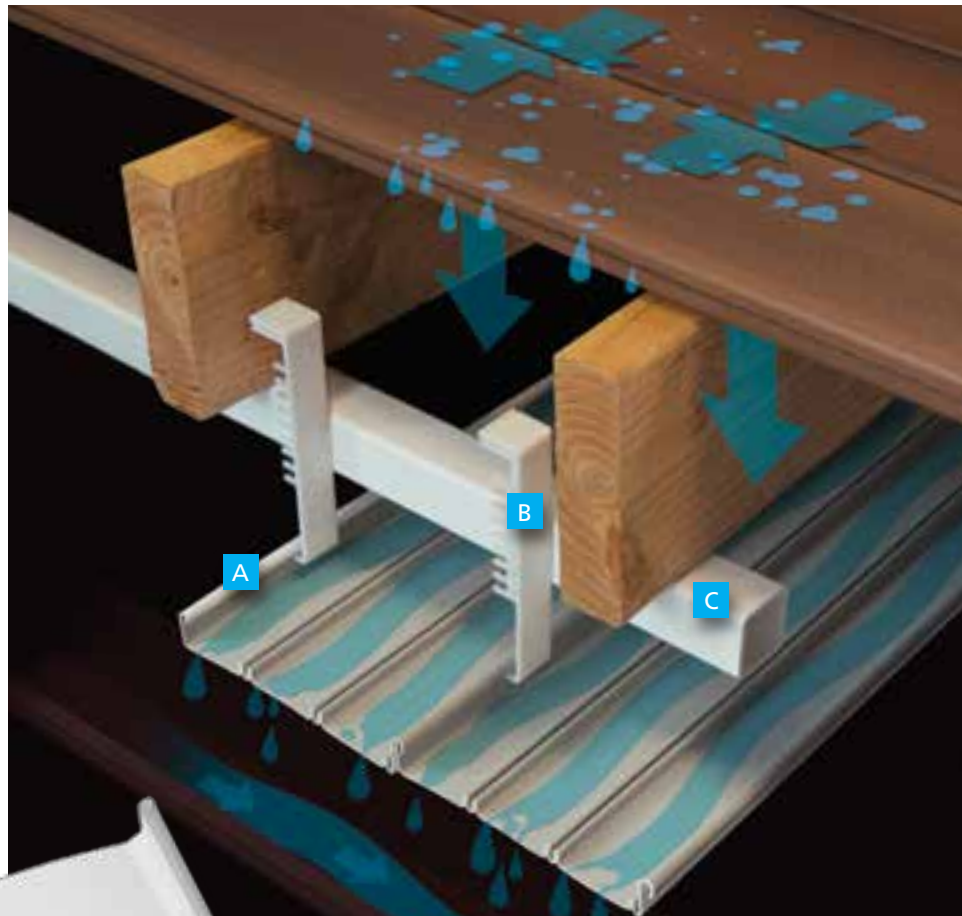

As precipitation drips between deck boards it is collected directly below by UnderShield and diverted away leaving a dry space under your deck. (Gutter sold separately. Not a CertainTeed product.)

Water drips on the panel surface may appear for various reasons including, but not limited to, dirt/debris build up and normal condensation.

Porch Accessories



CertainTeed Structural Porch Posts, Columns and finishing accessories complement any project, no matter which railing style or system is chosen.

- ◆ Pivoting mounting plate for easy installation of porch post
- ◆ Aluminum reinforced for rigidity and strength
- ◆ Load bearing
- ◆ Tie-down connection of porch post eliminates need for separate hurricane tie-down kit
- ◆ No overhead jacking required
- ◆ Class A flame-spread rating

Colonial
5" x 5"
108" length



Colonial
4" x 4"
108" length



Square
5" x 5"
108" length



Tapered Round
column 8" & 10"
108", 120" length



Non-tapered
Round
column 8"
108" length



Square 8"
108" length



Tie-down mounting plates and 4-piece post trim kits for top and bottom included with the post.

Cap and base trim sets sold separately, required for installation. 120" length available for 8" Tapered Round column only.

*Refer to product matrix for actual product specifications.

PORCH POSTS, WRAPS & COLUMNS



4" x 4" Certa-Snap Wrap smooth in white

6" x 6" Certa-Snap Wrap in Select Cedar texture with base trim

Designed to coordinate with CertainTeed's vinyl decking and railing products, Certa-Snap® Wrap delivers all of the low-maintenance benefits of vinyl posts without having to replace existing wood porch posts.

- ◆ Specially designed for existing wood posts
- ◆ 8-piece system — 4 vinyl post sections plus 4 corner trim pieces
- ◆ Components snap together for easy installation
- ◆ Available 4" x 4" or 6" x 6" in 10' lengths — can be field cut to any length
- ◆ Available in smooth and Select Cedar finish
- ◆ 4-piece post trim for top and bottom sold separately
- ◆ Class A flame-spread rating



White Smooth



Almond Smooth



White Select Cedar



Almond Select Cedar

Installation

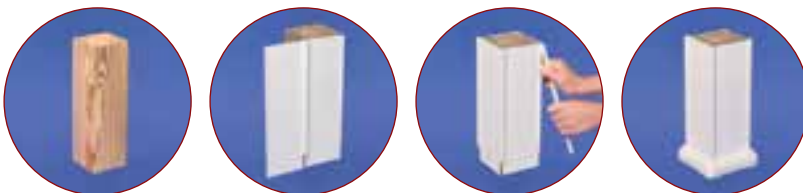

Trim accessory

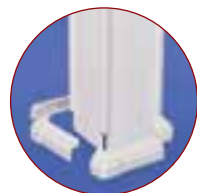

*Refer to product matrix for actual product specifications.

EverNew® Deck, Railing, Porch Posts, Wraps & Columns (at a glance)

Railing Systems		BALUSTER SIZE	BALUSTER STYLE	BALUSTER SPACING	SECTION WIDTH (FLAT NOMINAL)	SECTION WIDTH (FLAT ACTUAL)	SECTION HEIGHTS	RAILS (FLAT SECTIONS)	TOP RAIL STYLE	BOTTOM RAIL STYLE
CAPPED COMPOSITE	Panorama®	1-1/4" x 1-1/4" 5/8" x 5/8" Steel	Square Composite, Decorative Steel	3-5/8" Flat Composite 3-3/4" Flat Steel	72" 96"	67-1/2", 92-1/2"	3' and 3-1/2'	3-1/2" x 2-13/16" x 67-1/2" or 92-1/2" Top Rail	Classic	Classic
VINYL	Oxford	1-1/4" x 1-1/4"	Colonial, Square	3-3/8" Flat	72" 96" 120"	71-1/2", 95-1/2", 119-1/2"	3' and 3-1/2'	3" x 3-1/2" x 71-1/2", 95-1/2" or 119-1/2" "T" Shaped Top Rail	"T"- Rail	2 x 4
	Oxford T-Rail Glass Baluster Infill	4" x 3/8"	Tempered Glass: Clear and Smoked	3-7/8" Flat	72"	71-1/2"	3-1/2'	3" x 3-1/2" x 71-1/2" "T" Shaped Top Rail	"T"- Rail	2 x 4
	Kingston	1-1/2" x 1-1/2"	Traditional, Square	3-7/16" Flat	72" 96" 120"	68-1/2", 92-1/2", 116-1/2"	3' and 3-1/2'	3-1/4" x 1-1/2" x 68-1/2", 92-1/2" or 116-1/2" Top & Bottom	Top Round	Top Round

Measurements for all railing systems are from center to center of post. Note actual rail lengths.

*Vinyl railing is Canadian railing code compliant up to 8' span for exterior use guard rail system for 1 and 2 family dwellings.

Porch Posts, Wraps & Columns		DIMENSION	LENGTH	LOAD BEARING	FINISH	ALUMINUM REINFORCEMENT	INCLUDES MOUNTING PLATE	WARRANTY	SURESTART™
VINYL	Colonial Post	5"x 5"	108"	5000 lbs.	Smooth	yes	yes	Limited Lifetime Transferable	5-Year
	Colonial Post	4"x 4"	108"	2600 lbs.	Smooth	yes	yes	Limited Lifetime Transferable	5-Year
	Square Post	5"x 5"	108"	5000 lbs.	Smooth	yes	yes	Limited Lifetime Transferable	5-Year
	Square Column	8"x 8"	108"	18000 lbs.	Smooth	yes	yes	Limited Lifetime Transferable	5-Year
	Tapered Round Column	8", 10"	108", 120"	18000 lbs.	Smooth	yes	yes	Limited Lifetime Transferable	5-Year
	Non-Tapered Round Column	8"	108"	18000 lbs.	Smooth	yes	yes	Limited Lifetime Transferable	5-Year
	Certa-Snap® Wrap	4"x 4", 6"x 6"	120"	NA	Smooth Select Cedar	NA	NA	Limited Lifetime Transferable	5-Year

* 8" Tapered Round Column – 7-3/4" tapers to 6-1/8", 10" Tapered Round Column – 9-3/4" tapers to 8-1/8" (taper starts 48" from bottom)

** 120" length available for 8" Tapered Round Column only

Decking		BOARD SIZE (ACTUAL)	BOARD SPACING	BOARD SIZE	BOARD LENGTH (NOMINAL)	BOARD SURFACE	FASCIA SIZE (ACTUAL)	FASCIA LENGTH	FASCIA SURFACE	JOIST SPACING
VINYL	EverNew Vinyl Decking	1-1/2" x 5-1/2"	1/8"	2" x 6"	12', 16', 20'	Raised Ridge Tread	7/8"x6" or 3" or 1-1/2"	8'	Smooth	16"

Decking Accessory		STYLE	DIMENSION	THICKNESS	FINISH	WARRANTY
VINYL	UnderShield®	Chamfer or Beaded	Chamfer 6" x 16' Beaded 6" x 16' Fascia 4" x 16'	Chamfer .046" Beaded .046" Fascia .05"	Matte	Limited Lifetime

								COLOR AVAILABILITY					
REINFORCEMENT	RAIL-TO-POST CONNECTION	CODE*	APPLICATION	WARRANTY	SURESTART™	VALUE	WHITE	ALMOND	CLAY **	COLONIAL WHITE	STERLING GRAY	SAVANNAH WICKER	GRAY
Composite Core	Stainless steel concealed bracket engineered for flat, stair, and almost any angle	CCRR-0115	Suitable for 1 and 2-family dwellings and townhouses not more than 3-stories in height	25-Year Limited	2-Year	\$\$ - \$\$\$	●	●					
Aluminum Top & Bottom	Routed post option or aluminum brackets with molded covers for flat, stair, column and 45°	CCRR-0187	Suitable for residential and commercial applications – including multi-family and over 3-story installation	Limited Lifetime & Transferable	5-Year	\$\$ - \$\$\$	●	●	●				
Aluminum Top & Bottom	Routed post option or aluminum brackets with molded covers for flat, stair, column and 45°	CCRR-0187	Suitable for 1 and 2-family dwellings and townhouses not more than 3-stories in height	Limited Lifetime & Transferable	5-Year	\$\$\$\$	●	●	●				
Aluminum Top & Bottom	Aluminum brackets with molded covers for flat, stair, steep stair, column, 45° and 22-1/2°	CCRR-0211	Suitable for 1 and 2-family dwellings and townhouses not more than 3-stories in height	Limited Lifetime & Transferable	5-Year	\$\$-\$\$	●	●	●				

** ColorLast® Dark Color Fade Protection - Our acrylic formulation provides superior protection from the harsh rays of the sun, resulting in richer color that retains its vibrant hue for years to come. ColorLast is offered in Clay.

								COLOR AVAILABILITY						
								●	●					
								●	●					
								●	●	●				
								●						
								●						
								●						
								●	●					

					COLOR AVAILABILITY							
	CODE	APPLICATION	WARRANTY	SURESTART™								
	CCRR-0219	Decks, docks and porches	Limited Lifetime	5-Year		●	●					●

								COLOR AVAILABILITY						
											●	●	●	



CertainTeed products are designed to work together and complement each other in color and style to give your home a beautiful finished look.



Polymer Shakes & Shingles



Roofing and Ventilation



Fence



Insulated Siding



PVC Exterior Trim & Beadboard



Decking and Railing



Vinyl Siding



Vinyl Carpentry® Trim



Housewrap



Professional: [facebook.com/CertainTeedFreedomofChoice](https://www.facebook.com/CertainTeedFreedomofChoice)

Consumer: [facebook.com/CertainTeedLivingSpaces](https://www.facebook.com/CertainTeedLivingSpaces)

[Be Certain] Confidence worth building on.™

ASK ABOUT OUR OTHER CERTAINTEED® PRODUCTS AND SYSTEMS:

ROOFING • SIDING • TRIM • DECKING • RAILING • FENCE
GYPSUM • CEILINGS • INSULATION

www.certainteed.com <http://blog.certainteed.com>

CertainTeed Corporation
20 Moores Road
Malvern, PA 19355

Professional: 800-233-8990

Consumer: 800-782-8777

© 1/16 CertainTeed Corporation, Printed in U.S.A.
Code No. 40-70-425

